

# Amphenol<sup>®</sup>



## LPT Series Connectors

# Amphenol

## Table of Contents

● Company introduction .....	01
● Product introduction .....	02
● Market Applications .....	03
● Technical data .....	04
● How to order/Shell Type .....	05
● Crimp contact ordering info .....	06
● Machined contact ordering info .....	07
● Service class .....	08
● Alternate positioning .....	09
● Insert arrangements .....	10
● Product dimensions .....	12
● Assembly instructions .....	17

# Company Introduction



## Amphenol Industrial Operations

Amphenol Industrial Operations (AIO), a division of the Amphenol Corporation, is a prominent manufacturer of cylindrical connectors known around the world. Amphenol Industrial's product lines consist of rectangular, standard miniature, fiber optic, EMI/EMP filter, and a variety of special application connectors.

Manufacturing connectors since 1932, we take pride that the Amphenol Industrial Operations is the undisputed leader in interconnect systems for harsh environment applications. Innovations like our RADSOK® contact technology can provide roughly 50% more current through the same size pin. Connectors utilizing this RADSOK® technology will outperform similar products in the market hands down.

The Sidney, NY facility, nestled at the foothills of the Catskill Mountains, is over 307,000 square feet (28,521 m<sup>2</sup>). This complex houses over 1,000+ employees incorporating state-of-the-art manufacturing technologies. The facility is both ISO 9001 certified and qualified to MIL-STD-790 requirements.



## Amphenol Technology (Zhuhai) Co., Ltd

Established in 2007, Amphenol Technology (Zhuhai) Co., Ltd. is a manufacturing facility for Amphenol Industrial Operations, which serves a number of industrial markets, included but not limited to Factory Automation, Transportation, Heavy Equipment, Alternative Energy, Oil & Gas, Server/Data Comm and Power Distribution.

Amphenol Technology (Zhuhai) Co., Ltd. covers an area of 306,449 square feet (28,470 m<sup>2</sup>) and is equipped with CNCs, plating, injection molding and assembly workshops. This plant specializes in the design and manufacturing of industrial connectors featuring high power, high density inserts, medium to high voltage electrical properties, and harsh environment applications.

Many of the products produced here have been certified by independent standards including UL, IEC/TUV, ATEX, IECEx and MA. The facility is also certified to ISO 9001, ISO 14001 and TS16949.

## LPT Series Product Introduction



### What are LPT Series Connectors?

The LPT Series is based on the MIL-C-26482 Series I and Amphenol's original PT Series. Cost effective without sacrificing quality. This series is a cylindrical bayonet connector constructed with an aluminum shell and features stamped and formed crimped contacts.

### Features and Benefits

- Aluminum shell construction provides high strength while being light in weight
- Multiple shell plating options (up to 500H salt spray protection)
- Stamped and formed crimp contacts with a 3 tine retention system
- Machined contacts available
- Off the shelf availability
- Quick positive bayonet coupling
- 5 key/keyway mating
- Ingress protection up to IP67 and IP69K when in the mated condition
- High shock and high vibration resistance
- Operating temperature range: -40°C to 125°C
- Intermateable with Amphenol's PT series
- PT standard shells have years of proven performance in the field
- UL/TUV certifications in process

### Structure Features

#### 5 Shell Styles :

- ① Box mounting receptacle
- ② Jam nut receptacle
- ③ Straight plug
- ④ Wall mounting receptacle
- ⑤ Cable connecting receptacle

#### 3 Connector Finishes Available:

- ① Black zinc (RoHS)
- ② Nickel (RoHS)
- ③ Gray zinc nickel(RoHS)

#### 4 Alternate Positioning :

Insert rotation W,X,Y,Z

#### Crimp Contact Size :

- ① #12: 14-12 (2.00-3.50mm<sup>2</sup>)
- ② #16: 18-16 (0.75-1.50mm<sup>2</sup>)
- ③ #20: 22-20 (0.34-0.50mm<sup>2</sup>)
- ④ Contact our sales team if you need RADSOK® or alternate size contact options

## Market Applications

Widely used in general and harsh environments, the LPT Series is suitable for markets including but not limited to the following:

- Industrial Instrumentation
- Security
- Telecommunications
- Robotics/Factory Automation
- Process Control
- Energy Storage
- Hybrid/Electric Vehicle
- Heavy Equipment
- Rail Mass Transit



## Technical Data

Shell Material	Aluminum	
Insert Material	Plastic	
Contact	Material	Copper alloy
	Plating	Tin/Nickel/Gold plated
	Termination	Crimp
Temperature Range	-40°C to +125°C	
Ingress Protection	IP67&IP69K in the mated condition A basic dust cover or an IP67 compliant cap are available for protection in the unmated condition	
Test Current	20# contact 5A	
	16# contact 13A	
	12# contact 23A/35A with RADSOK®	
Recommended Operating Voltage	I # 250V	
	II# 500V	
Test Voltage AC	I # 1500V	
	II# 2300V	
Mating Cycles	500 Cycles	
Salt Spray Test	1. Black Zinc (non-conductive): 48H 2. Nickel (conductive): 48H 3. Gray Zinc Nickel (conductive): 500H	
Vibration	In accordance with test procedure EIA-364-28	
Thermal Shock	In accordance with test procedure EIA-364-32	
RoHS	Compliant	

# How to Order

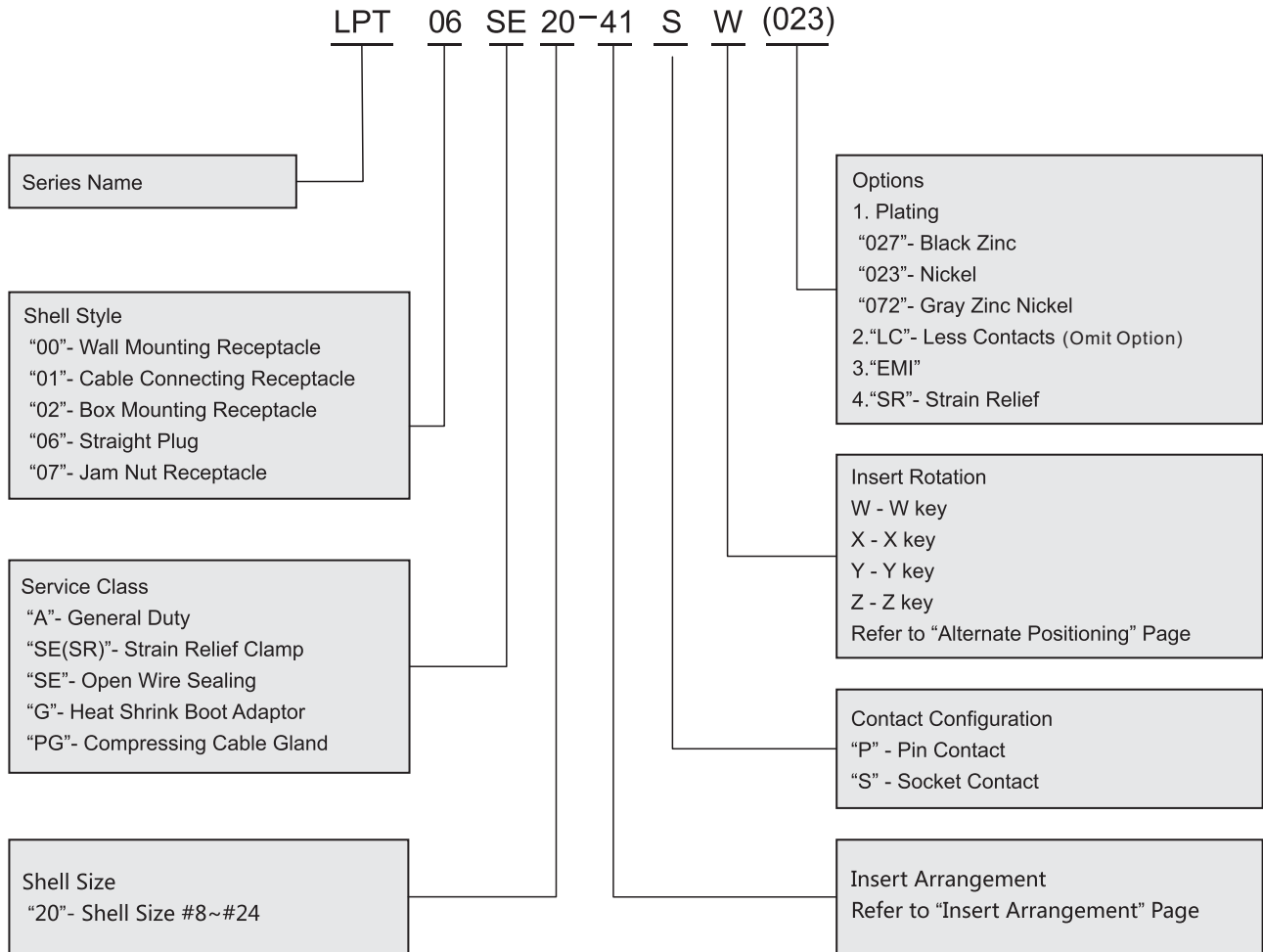

Note: Contacts must be ordered separately, see page 6 thru 7

# Shell Type

Wall Mounting Receptacle  
LPT00



Cable Connecting Receptacle  
LPT01



Box Mounting Receptacle  
LPT02



Straight Plug  
LPT06



Jam Nut Receptacle  
LPT07



## Crimp Contact Ordering Information



Size	Current (A)	PIN/SOCKET	Wire		Plating	Part No	Pcs/Reel
			AWG	mm <sup>2</sup>			
#20	5	PIN	22-20	0.34-0.50	Tin plating	LPTC-SF-20P-20-1	3000
					Ni plating	LPTC-SF-20P-20-2	
					Gold flash	LPTC-SF-20P-20-3	
					10u"gold plating	LPTC-SF-20P-20-4	
					30u"gold plating	LPTC-SF-20P-20-5	
		SOCKET	22-20	0.34-0.50	Tin plating	LPTC-SF-20S-20-1	
					Ni plating	LPTC-SF-20S-20-2	
					Gold flash	LPTC-SF-20S-20-3	
					10 u"gold plating	LPTC-SF-20S-20-4	
					30 u"gold plating	LPTC-SF-20S-20-5	
#16	13	PIN	16-18	0.75-1.50	Tin plating	UPTC-SF-16P-16-1	3000
					Ni plating	UPTC-SF-16P-16-2	
					Gold flash	UPTC-SF-16P-16-3	
					10u"gold plating	UPTC-SF-16P-16-4	
					30u"gold plating	UPTC-SF-16P-16-5	
			20-22	0.34-0.50	Tin plating	UPTC-SF-16P-20-1	
					Ni plating	UPTC-SF-16P-20-2	
					Gold flash	UPTC-SF-16P-20-3	
					10u"gold plating	UPTC-SF-16P-20-4	
					30u"gold plating	UPTC-SF-16P-20-5	
		SOCKET	16-18	0.75-1.50	Tin plating	UPTC-SF-16S-16-1	
					Ni plating	UPTC-SF-16S-16-2	
					Gold flash	UPTC-SF-16S-16-3	
					10u"gold plating	UPTC-SF-16S-16-4	
					30u"gold plating	UPTC-SF-16S-16-5	
			20-22	0.34-0.50	Tin plating	UPTC-SF-16S-20-1	
					Ni plating	UPTC-SF-16S-20-2	
					Gold flash	UPTC-SF-16S-20-3	
					10u"gold plating	UPTC-SF-16S-20-4	
					30u"gold plating	UPTC-SF-16S-20-5	
#12	23	PIN	12~14	2.00-3.50	Tin plating	LPTC-SF-12P-12-1	1000
					Ni plating	LPTC-SF-12P-12-2	
					Gold flash	LPTC-SF-12P-12-3	
					10u"gold plating	LPTC-SF-12P-12-4	
					30u"gold plating	LPTC-SF-12P-12-5	
		SOCKET	12~14	2.00-3.50	Tin plating	LPTC-SF-12S-12-1	
					Ni plating	LPTC-SF-12S-12-2	
					Gold flash	LPTC-SF-12S-12-3	
					10u"gold plating	LPTC-SF-12S-12-4	
					30u"gold plating	LPTC-SF-12S-12-5	



## Machined Contact Ordering Information

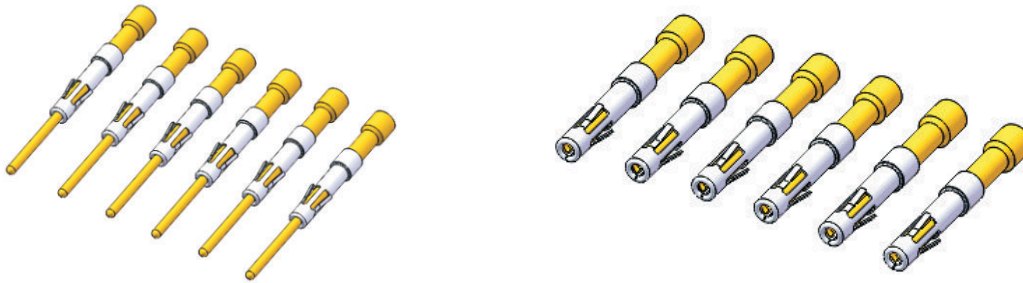

Size	Current (A)	PIN/SOCKET	Wire		Plating	Part No
			AWG	mm <sup>2</sup>		
#20	5	PIN	22-20	0.34-0.50	Tin plating	LPTC-MA-20P-20-1
					Ni plating	LPTC-MA-20P-20-2
					Gold flash	LPTC-MA-20P-20-3
					10u"gold plating	LPTC-MA-20P-20-4
					30u"gold plating	LPTC-MA-20P-20-5
		SOCKET	22-20	0.34-0.50	Tin plating	LPTC-MA-20S-20-1
					Ni plating	LPTC-MA-20S-20-2
					Gold flash	LPTC-MA-20S-20-3
					10 u"gold plating	LPTC-MA-20S-20-4
					30 u"gold plating	LPTC-MA-20S-20-5
#16	13	PIN	16-18	0.75-1.50	Tin plating	UPTC-MA-16P-16-1
					Ni plating	UPTC-MA-16P-16-2
					Gold flash	UPTC-MA-16P-16-3
					10u"gold plating	UPTC-MA-16P-16-4
					30u"gold plating	UPTC-MA-16P-16-5
			20-22	0.34-0.50	Tin plating	UPTC-MA-16P-20-1
					Ni plating	UPTC-MA-16P-20-2
					Gold flash	UPTC-MA-16P-20-3
					10u"gold plating	UPTC-MA-16P-20-4
					30u"gold plating	UPTC-MA-16P-20-5
		SOCKET	16-18	0.75-1.50	Tin plating	UPTC-MA-16S-16-1
					Ni plating	UPTC-MA-16S-16-2
					Gold flash	UPTC-MA-16S-16-3
					10u"gold plating	UPTC-MA-16S-16-4
					30u"gold plating	UPTC-MA-16S-16-5
			20-22	0.34-0.50	Tin plating	UPTC-MA-16S-20-1
					Ni plating	UPTC-MA-16S-20-2
					Gold flash	UPTC-MA-16S-20-3
					10u"gold plating	UPTC-MA-16S-20-4
					30u"gold plating	UPTC-MA-16S-20-5
#12	23	PIN	12~14	2.00-3.50	Tin plating	LPTC-MA-12P-12-1
					Ni plating	LPTC-MA-12P-12-2
					Gold flash	LPTC-MA-12P-12-3
					10u"gold plating	LPTC-MA-12P-12-4
					30u"gold plating	LPTC-MA-12P-12-5
		SOCKET	12~14	2.00-3.50	Tin plating	LPTC-MA-12S-12-1
					Ni plating	LPTC-MA-12S-12-2
					Gold flash	LPTC-MA-12S-12-3
					10u"gold plating	LPTC-MA-12S-12-4
					30u"gold plating	LPTC-MA-12S-12-5

## Service Classes

The LPT connector is available in the following certified service classes:



"A"	General duty; back shell is threaded for conduit attachment of MS3057 cable clamp.
"SE(SR)"	Strain relief clamp - environmental resistant strain relief clamp and grommet for moisture proofing individual wires; provides added wire bundle support.
"SE"	Open wire sealing environmental resistant, with a nut and grommet for moisture proofing individual wires.
"G"	Heat shrink boot adaptor- back shell for heat shrink boot, with optional grommet for moisture proofing individual wires.
"PG"	Compressing cable gland for moisture proofing jacketed cables with option of EMI shielding function.

## Alternate Positioning

### Alternate Positioning

To avoid cross-mating problems in applications requiring the use of more than one miniature cylindrical connector of the same size and arrangement, alternate insert rotations are available as indicated in the accompanying chart.

As shown in the diagram at the right, the front face of the pin insert is rotated within the shell in a clockwise direction from the normal shell key. The socket insert would be rotated counterclockwise the same number of degrees in respect to the normal shell key.

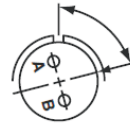

Position W

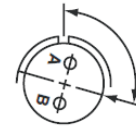

Position X

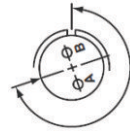

Position Y

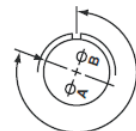



Position Z

Insert Rotation					
Shell Size	Insert Arrangement	Degrees			
		W	X	Y	Z
8	8-4	45	97	184	-
10	10-2	45	90	315	
10	10-6	90	-	-	-
12	12-4	38	-	-	-
12	12-8	90	112	203	292
12	12-10	60	155	270	295
14	14-5	40	92	184	273
14	14-8	48	162	189	312
14	14-19	30	165	315	
14	14-AA	45	-	-	-

Insert Rotation					
Shell Size	Insert Arrangement	Degrees			
		W	X	Y	Z
16	16-8	54	152	180	331
16	16-26	60	-	275	338
18	18-5	55	97	263	315
18	18-8	180	-	-	-
18	18-11	62	119	241	340
18	18-32	85	138	222	265
20	20-16	238	318	333	347
20	20-41	45	126	225	-
22	22-55	30	142	226	314
24	24-31	90	225	255	-

## Insert Arrangements

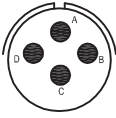
Pole	4	2	6	4
Insert Arrangement				
	8-4	10-2	10-6	12-4
Service Rating	I	I	I	I
Total Contacts	4	2	6	4
Contact No.	20	16	20	16

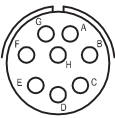
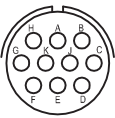
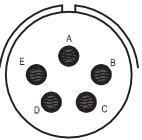
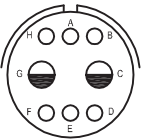
Pole	8	10	5	8
Insert Arrangement				
	12-8	12-10	14-5	14-8
Service Rating	I	I	II	I
Total Contacts	8	10	5	6 2
Contact No.	20	20	16	20 12

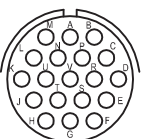
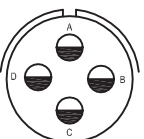
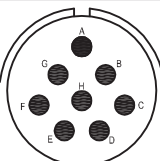
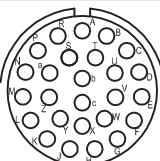
Pole	19	4	8	26
Insert Arrangement				
	14-19	14-AA	16-8	16-26
Service Rating	I	I	II	I
Total Contacts	19	4	8	26
Contact No.	20	12	16	20

# Insert Arrangements

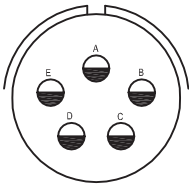
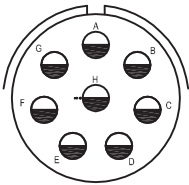
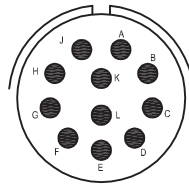
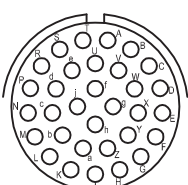
Pole	5	8	11	32
Insert Arrangement				
	18-5	18-8	18-11	18-32
Service Rating	II	I	II	I
Total Contacts	5	8	11	32
Contact No.	12	12	16	20

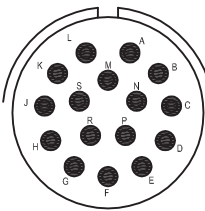
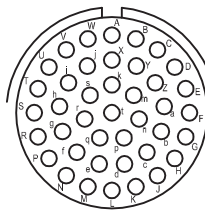
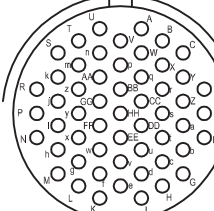
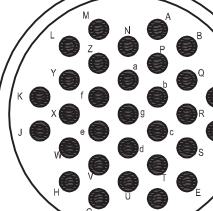
Pole	16	41	55	31
Insert Arrangement				
	20-16	20-41	22-55	24-31
Service Rating	II	I	I	I
Total Contacts	16	41	55	31
Contact No.	16	20	20	16

## Product Dimensions

### LPT00 (Wall Mounting Receptacle & Back Shells)

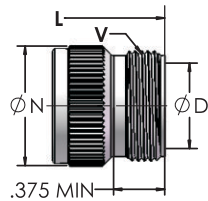
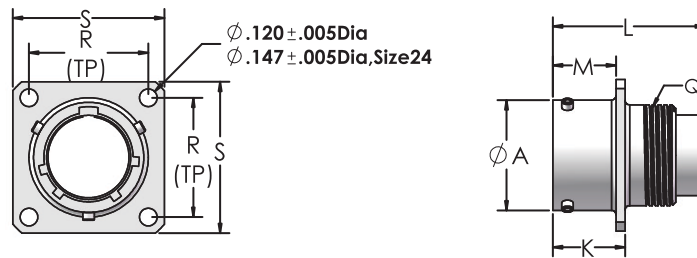

Class "A"

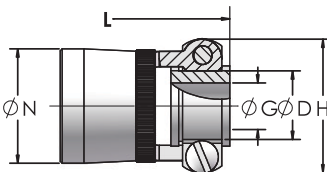

Class "SE(SR)"

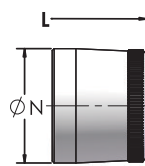

Class "SE"

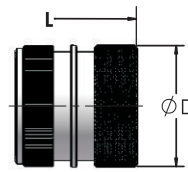

Class "G"

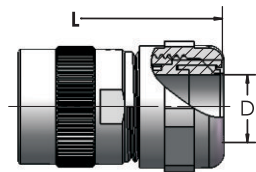

Class "PG"

Shell size	Receptacle Front View		Receptacle side view						CLASS "A"				CLASS "SE(SR)"	
	R	S	A	M	K	L		Q	D	L	N	V	D	G
			+.001 -.005	+.010 -.000	+.020 -.010	Max.		Thread Class 2A	Min.	Max.	Max.	Thread Class A	Min.	Max.
						PIN	SOCKET							
8	.594	.812	.473	.431	.493	1.270	1.056	.4375-28UNEF	.297	1.633	.590	.5000-28UNEF	.240	.125
10	.719	.938	.590	.431	.493	1.270	1.056	.5625-24NEF	.421	1.633	.717	.6250-24NEF	.302	.188
12	.812	1.031	.750	.431	.493	.127	1.056	.6875-24NEF	.546	1.633	.834	.7500-20UNEF	.428	.312
14	.906	1.125	.875	.431	.493	.127	1.056	.8125-20UNEF	.663	1.633	.970	.8750-20UNEF	.552	.375
16	.969	1.219	1.000	.431	.493	1.270	1.056	.9375-20UNEF	.787	1.633	1.088	1.0000-20UNEF	.615	.500
18	1.062	1.312	1.125	.431	.493	1.270	1.056	1.0625-18NEF	.879	1.633	1.216	1.1875-18NEF	.740	.625
20	1.156	1.438	1.250	.556	.650	1.332	1.164	1.1875-18NEF	1.014	1.674	1.332	1.1875-18NEF	.740	.625
22	1.250	1.562	1.375	.556	.650	1.332	1.164	1.3125-18NEF	1.134	1.674	1.460	1.4375-18NEF	.928	.750
24	1.375	1.688	1.500	.589	.683	1.332	1.164	1.4375-18NEF	1.259	1.674	1.585	1.4375-18NEF	.990	.800

Shell size	CLASS "SE(SR)"				CLASS "SE"			CLASS "G"		CLASS "PG"		
	H	L		N	L		N	L	N	N	D	L
	Max.	Max.		Max.	Max.		Max.	Max.	Max.	REF	Cable range (mm)	REF
		PIN	SOCKET		PIN	SOCKET						
8	.812	2.354	2.202	.550	1.746	1.538	.560	1.768	.620	.571	3-6.5	2.309
10	.875	2.354	2.202	.675	1.746	1.538	.685	1.768	.730	.814	4-8	2.309
12	1.000	2.354	2.202	.803	1.746	1.538	.813	1.768	.939	.814	4-8	2.309
14	1.125	2.354	2.202	.920	1.746	1.538	.930	1.768	.971	.930	5-10	2.309
16	1.188	2.486	2.272	1.047	1.746	1.538	1.057	1.768	1.179	1.120	10-14	2.309
18	1.438	2.486	2.272	1.165	1.746	1.750	1.175	1.768	1.266	1.180	13-18	2.309
20	1.438	2.684	2.470	1.290	1.918	1.750	1.301	1.980	1.427	1.296	13-18	2.385
22	1.625	2.684	2.470	1.418	1.918	1.750	1.430	1.980	1.522	1.496	18-25	2.385
24	1.719	2.684	2.470	1.543	1.918	1.750	1.555	1.980	1.644	1.562	18-25	2.385

# Product Dimensions

## LPT01 (Cable Connecting Receptacle & Back Shells)

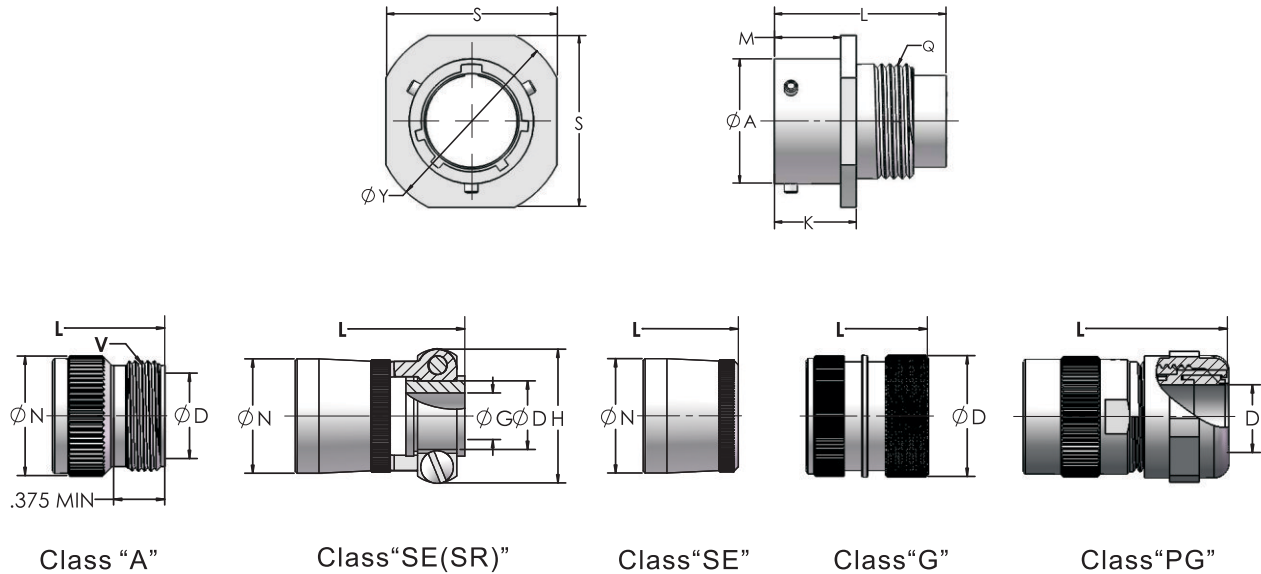

Shell size	Receptacle Front View		Receptacle side view						CLASS "A"				CLASS "SE(SR)"	
	S	Y	A	M	K	L		Q	D	L	N	V	D	G
	±.020	±.020	+ .001	+ .010	+ .020	Max.		Thread	Min.	Max.	Max.	Thread	Min.	Max.
			-.005	-.000	-.010	PIN	SOCKET	Class 2A				Class A		
8	.812	.938	.473	.400	.494	1.270	1.056	.4375-28UNEF	.297	1.633	.590	.5000-28UNEF	.240	.125
10	.938	1.062	.590	.400	.494	1.270	1.056	.5625-24NEF	.421	1.633	.717	.6250-24NEF	.302	.188
12	1.031	1.156	.750	.400	.494	.127	1.056	.6875-24NEF	.546	1.633	.834	.7500-20UNEF	.428	.312
14	1.125	1.250	.875	.400	.494	.127	1.056	.8125-20UNEF	.663	1.633	.970	.8750-20UNEF	.552	.375
16	1.219	1.344	1.000	.400	.494	1.270	1.056	.9375-20UNEF	.787	1.633	1.088	1.0000-20UNEF	.615	.500
18	1.312	1.438	1.125	.400	.494	1.270	1.056	1.0625-18NEF	.879	1.633	1.216	1.1875-18NEF	.740	.625
20	1.438	1.562	1.250	.535	.650	1.332	1.164	1.1875-18NEF	1.014	1.674	1.332	1.1875-18NEF	.740	.625
22	1.562	1.688	1.375	.535	.650	1.332	1.164	1.3125-18NEF	1.134	1.674	1.460	1.4375-18NEF	.928	.750
24	1.688	1.812	1.500	.568	.683	1.332	1.164	1.4375-18NEF	1.259	1.674	1.585	1.4375-18NEF	.990	.800

Shell size	CLASS "SE(SR)"			CLASS "SE"			CLASS "G"		CLASS "PG"			
	H	L		N	L		N	L	N	N	D	L
	Max.	Max.		Max.	Max.		Max.	Max.	Max.	REF	Cable range	REF
		PIN	SOCKET		PIN	SOCKET					(mm)	
8	.812	2.354	2.202	.550	1.746	1.538	.560	1.768	.620	.571	3-6.5	2.309
10	.875	2.354	2.202	.675	1.746	1.538	.685	1.768	.730	.814	4-8	2.309
12	1.000	2.354	2.202	.803	1.746	1.538	.813	1.768	.939	.814	4-8	2.309
14	1.125	2.354	2.202	.920	1.746	1.538	.930	1.768	.971	.930	5-10	2.309
16	1.188	2.486	2.272	1.047	1.746	1.538	1.057	1.768	1.179	1.120	10-14	2.309
18	1.438	2.486	2.272	1.165	1.746	1.750	1.175	1.768	1.266	1.180	13-18	2.309
20	1.438	2.684	2.470	1.290	1.918	1.750	1.301	1.980	1.427	1.296	13-18	2.385
22	1.625	2.684	2.470	1.418	1.918	1.750	1.430	1.980	1.522	1.496	18-25	2.385
24	1.719	2.684	2.470	1.543	1.918	1.750	1.555	1.980	1.644	1.562	18-25	2.385

## Product Dimensions

### LPT02 (Box Mounting Receptacle)

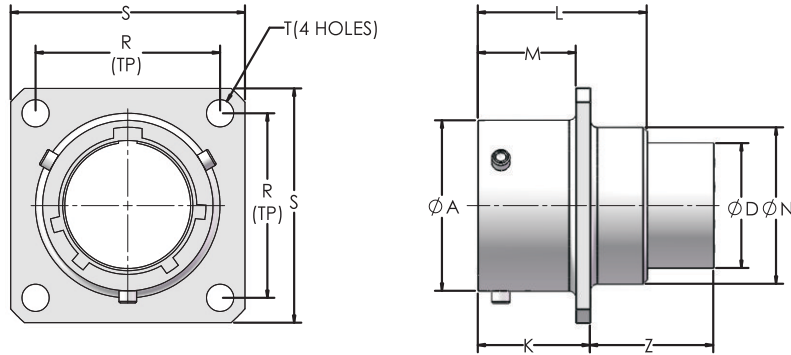

Shell size	Receptacle Front View			Receptacle side view							
	R	S	T	A	D	K	L	M	N	Z	
			±.005	+ .001 - .005	Max.	+ .020 - .010	Max.	+ .020 - .010	Dia. Max.	Max.	PIN
8	.594	.812	.120	.473	.326	.493	.825	.431	.449	.777	.563
10	.719	.938	.120	.590	.443	.493	.825	.431	.573	.777	.563
12	.812	1.031	.120	.750	.557	.493	.825	.431	.699	.777	.563
14	.906	1.125	.120	.875	.682	.493	.825	.431	.823	.777	.563
16	.969	1.219	.120	1.000	.807	.493	.825	.431	.949	.777	.563
18	1.062	1.312	.120	1.125	.908	.493	.825	.431	1.073	.777	.563
20	1.156	1.438	.120	1.250	1.033	.650	1.076	.556	1.199	.682	.514
22	1.250	1.562	.120	1.375	1.158	.650	1.076	.556	1.323	.682	.514
24	1.375	1.688	.147	1.500	1.283	.683	1.109	.589	1.449	.649	.481



# Product Dimensions

## LPT06 (Straight Plug & Back Shells)

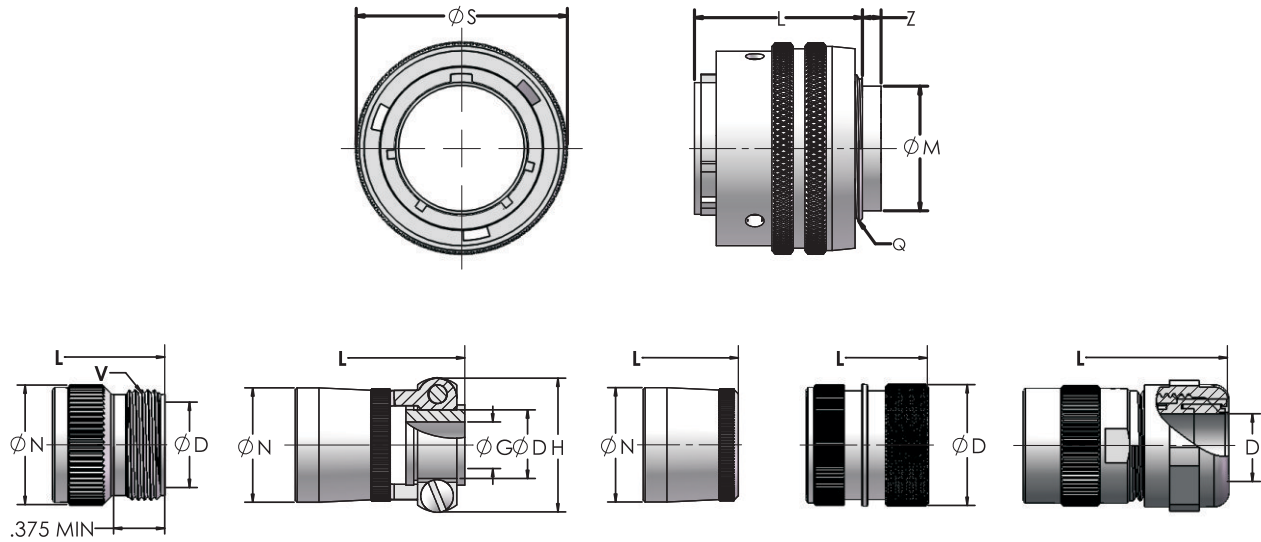

Class "A"

Class "SE(SR)"

Class "SE"

Class "G"

Class "PG"

Shell size	Plug Front View	Plug Side View					CLASS "A"				CLASS "SE(SR)"	
	S	L	M	Q	Z		D	L	N	V	D	G
	Max.	Max.	Max.	Thread Class 2A	Max.		Min.	Max.	Max.	Thread Class A	Min.	Max.
					PIN	SOCKET						
8	.750	.928	.326	.4375-28UNEF	.324	.110	.326	1.615	.590	.5000-28UNEF	.240	.125
10	.859	.928	.443	.5625-24NEF	.324	.110	.443	1.615	.717	.6250-24NEF	.302	.188
12	1.031	.928	.557	.6875-24NEF	.324	.110	.557	1.615	.834	.7500-20UNEF	.428	.312
14	1.156	.928	.682	.8125-20UNEF	.324	.110	.682	1.615	.970	.8750-20UNEF	.552	.375
16	1.281	.928	.807	.9375-20UNEF	.324	.110	.807	1.615	1.088	1.0000-20UNEF	.615	.500
18	1.391	.928	.908	1.0625-18NEF	.324	.110	.908	1.615	1.216	1.1875-18NEF	.740	.625
20	1.531	1.000	1.033	1.1875-18NEF	.248	.080	1.033	1.594	1.332	1.1875-18NEF	.740	.625
22	1.656	1.000	1.158	1.3125-18NEF	.248	.080	1.158	1.594	1.460	1.4375-18NEF	.928	.750
24	1.776	1.000	1.283	1.4375-18NEF	.248	.080	1.283	1.594	1.587	1.4375-18NEF	.990	.800

Shell size	CLASS "SE(SR)"			CLASS "SE"		CLASS "G"		CLASS "PG"				
	H	L		N	N	L	L	N	N	D	L	
	Max.	Max.		Max.	Max.	Max.		Max.	Max.	REF	Cable range (mm)	REF
		Pin	Socket			PIN	SOCKET					
8	.812	2.336	2.122	.550	.560	1.728	1.520	1.750	.620	.571	3-6.5	2.291
10	.875	2.336	2.122	.675	.685	1.728	1.520	1.750	.730	.814	4-8	2.291
12	1.000	2.336	2.122	.803	.813	1.728	1.520	1.750	.939	.814	4-8	2.291
14	1.125	2.336	2.122	.920	.930	1.728	1.520	1.750	.971	.930	5-10	2.291
16	1.188	2.468	2.254	1.047	1.057	1.728	1.520	1.750	1.179	1.120	10-14	2.291
18	1.438	2.468	2.254	1.165	1.175	1.728	1.520	1.750	1.266	1.180	13-18	2.291
20	1.438	2.604	2.390	1.290	1.301	1.838	1.670	1.900	1.427	1.296	13-18	2.305
22	1.625	2.604	2.390	1.418	1.430	1.838	1.670	1.900	1.522	1.496	18-25	2.305
24	1.719	2.604	2.390	1.543	1.555	1.838	1.670	1.900	1.644	1.562	18-25	2.305

## Product Dimensions

### LPT07 (Jam Nut Receptacle)

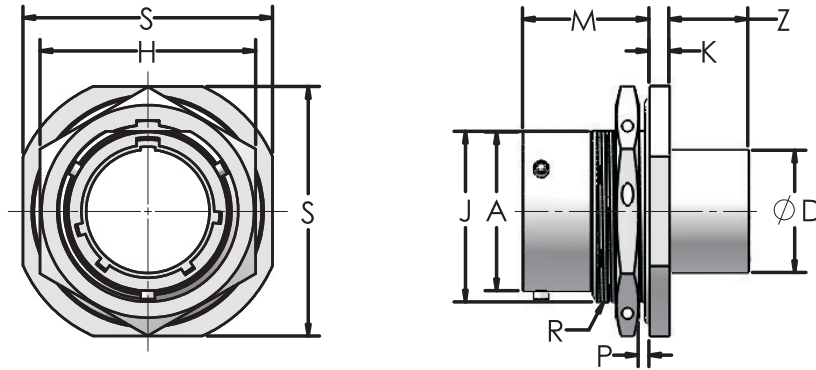

Shell size	Receptacle Front View					Receptacle side view							
	H ±.016	S	A	D	J Flat	K	M	P Panel thickness		R	Z		
			+ .001	Dia.	+ .000			+ .011	Min.	Max.	Thread	Max.	
			- .005	Max.	- .010			- .010				PIN	SOCKET
8	.750	.938	.473	.326	.530	.125	.696	.062	.125	.5625-24	.450	.235	
10	.875	1.062	.590	.443	.655	.125	.696	.062	.125	.6875-24	.450	.235	
12	1.062	1.250	.750	.557	.818	.125	.696	.062	.125	.8750-20	.450	.235	
14	1.188	1.375	.875	.682	.942	.125	.696	.062	.125	1.0000-20	.450	.235	
16	1.312	1.500	1.000	.807	1.066	.125	.696	.062	.125	1.1250-18	.450	.235	
18	1.438	1.625	1.125	.908	1.191	.125	.696	.062	.125	1.2500-18	.450	.235	
20	1.562	1.812	1.250	1.033	1.316	.156	.884	.062	.250	1.3750-18	.292	.124	
22	1.688	1.938	1.375	1.158	1.441	.156	.884	.062	.250	1.5000-18	.292	.124	
24	1.816	2.062	1.500	1.283	1.566	.156	.917	.062	.250	1.6250-18	.260	.092	

## Assembly Instructions (Contact)

### 1. Stripping (20# AWG LPT series contact)

- 1) Tooling: Wire cutting machine
- 2) Wire: 20~22 AWG wire
- 3) Cut wire according to length requirement, strip insulation, recommended length 4.0~4.5mm



(Wire cutting machine)

### 2. Contact Crimping

- 1) Tooling: Crimping machine
- 2) Prepare stripped wire and contact
- 3) Crimp contact to wire following the IPC-A-620 standard

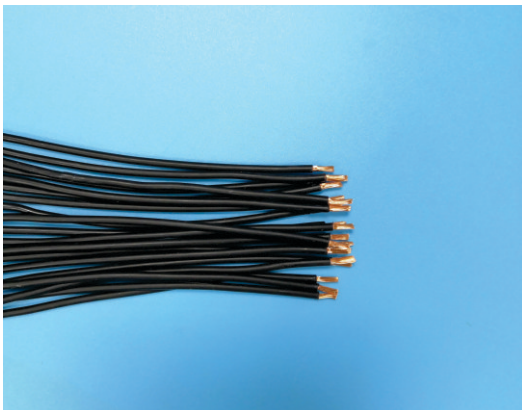

(Stripped wire )



(Crimping machine)

### 3. Crimped Contact

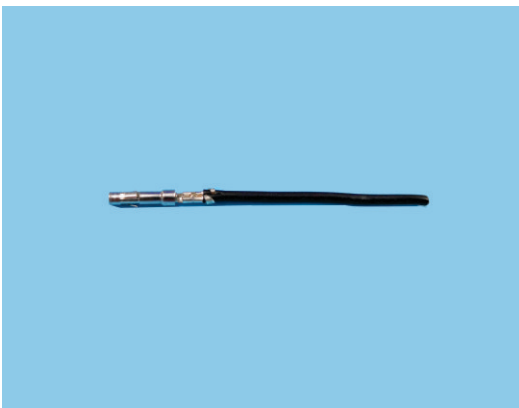

( SOCKET )

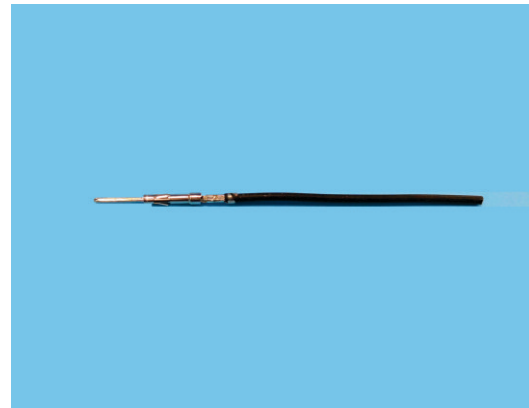

( PIN )

## Assembly Instructions (Receptacle)

### Receptacle Assembly

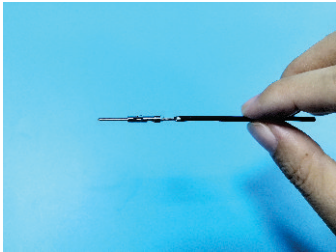

1. Take your wire with crimped contact

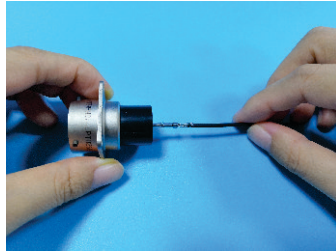

2. Insert crimped contact into corresponding insert location

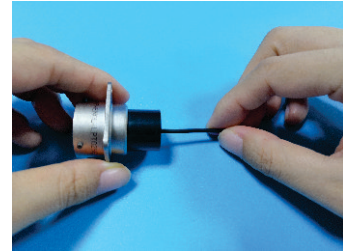

3. Personnel inserting contacts will normally “feel” the contact reach its fully seated position. Visually check the mating ends of the connector to be sure all contacts are properly inserted to the same depth (a slight pull to confirm contact retention can also be implemented)

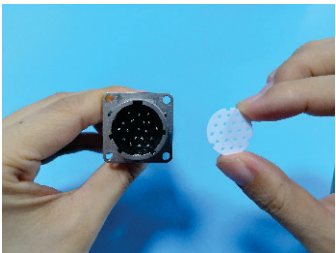

4. Insert locator set to the proper position on the front side of the connector

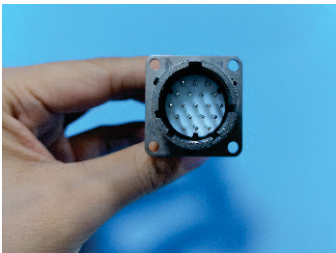

5. Push locator to bottom of shell front

※Locator used for pin contact Receptacle/Plug

### Receptacle Extraction

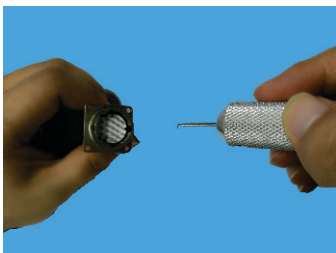

1. Prepare insertion/ extraction tool

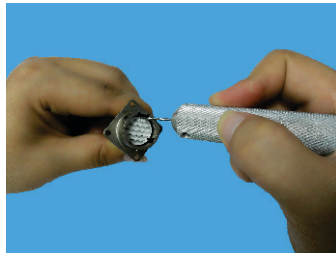

2. Hook groove of locator with the tool to pull out locator from connector

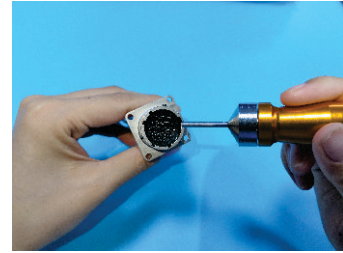

3. Insert tool over appropriate contact for removal



4. Push contact extraction tool to bottom



5. Apply pressure on the handle end of the tool and pull the contact out of the connector rear

## Assembly Instructions (Plug)

### Plug Assembly

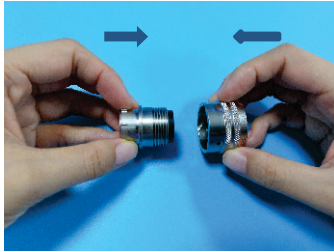

1. Assemble coupling nut with plug shell

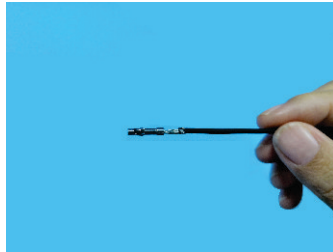

2. Prepare wire with crimped contact

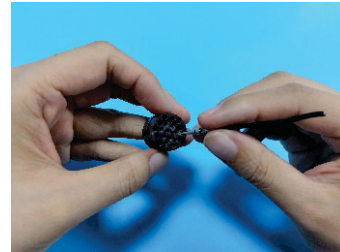

3. Grip contact and push through the grommet

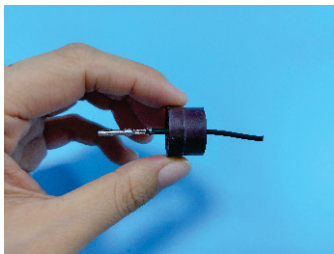

4. Insert at least 2 cables to fix the position for the remainder of the contacts

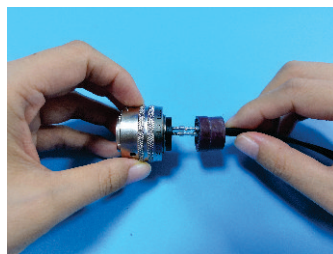

5. Personnel inserting contacts will normally feel the contact reach its fully seated position

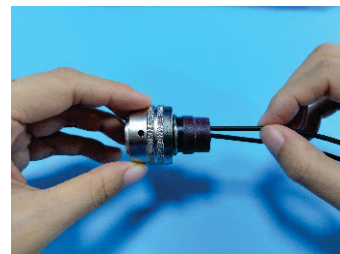

6. Push the grommet so it rests against the insulator face on the rear of the shell

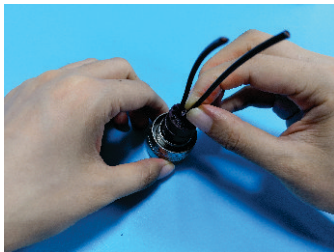

7. Continue to seat the remainder of the contacts



8. Re-check to make sure the grommet is against the insulator face after all contacts are seated

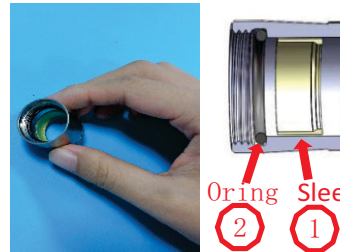

9. Assemble sleeve and o-ring into the rear nut



10. Feed wires through nut

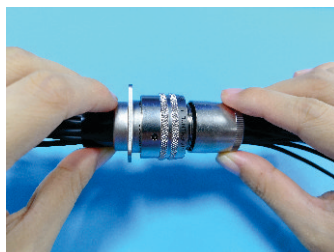

11. Connect plug to receptacle for stability and move backshell up to rear threads

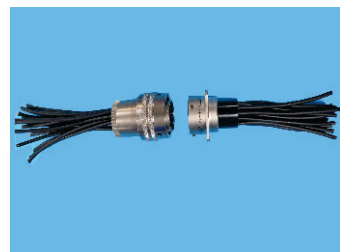

12. Thread and tighten backshell then unmate from receptacle

## Assembly Instructions (Plug)

### Plug Contact Extraction

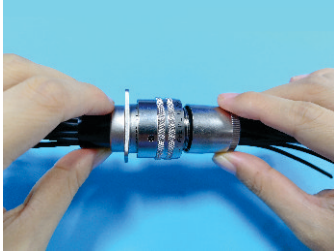

1. Mate plug to receptacle for stability

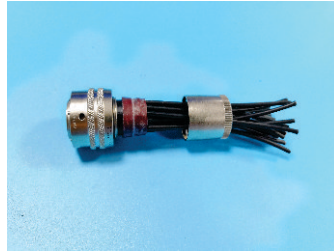

2. Loosen and remove backshell from plug



3. Place insertion/extraction tool over desired contact



4. Push tool until it bottoms out

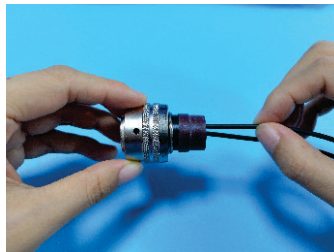

5. Apply pressure on the handle end of the tool and pull the contact out of the connector rear

## North America

### Amphenol Industrial Product Group

191 Delaware Avenue  
Sidney, NY 13838-1395-USA

Telephone: 888-364-9011 Fax:520-397-7169

[www.amphenol-industrial.com](http://www.amphenol-industrial.com)

## Asia

### Amphenol Technology (Zhuhai) Co.,Ltd.

Address:No.63, Xinghan Rd, Phase 2, Science and Technology  
Industrial Park, Sanzao Town, Jinwan, Zhuhai, PRC

Tel: (86)756-3989725 Fax: (86) 756-3989768

[www.amphenol-industrial.com](http://www.amphenol-industrial.com)



Notice: Specifications are subject to change without notice. Contact your nearest Amphenol Corporation Sales Office for the latest specifications. All statements, information and data given herein are believed to be accurate and reliable but are presented without guarantee, warranty, or responsibility of any kind expressed or implied. Statements or suggestions concerning possible use of our products are made without representation or warranty that any such use is free of patent infringement and are not recommendations to infringe any patent. The user should not assume that all safety measures are indicated or that other measures may not be required. Specifications are typical and may not apply to all connectors.