

Max-M12 Series





ABOUT US

Amphenol

Amphenol Industrial Operations

Amphenol Industrial Operations (AIO), a division of the Amphenol Corporation, is a prominent manufacturer of cylindrical connectors known around the world. Amphenol Industrial's product lines consist of rectangular, standard miniature, fiber optic, EMI/EMP filter, and a variety of special application connectors.

Manufacturing connectors since 1932, we take pride that Amphenol Industrial Operations is the undisputed leader in interconnect systems for harsh environment applications. Innovations like our RADSOK® contact technology can provide roughly 50% more current through the same size pin. Connectors utilizing this RADSOK® technology will outperform similar products in the market hands down.

The Sidney, NY facility, nestled at the foothills of the Catskill Mountains, is over 307,000 square feet. This complex houses over 1000+employees incorporating state-of-the-art manufacturing technologies. The facility is both ISO9001 certified and qualified to MIL-STD-790 requirements.



Sidney Factory

Amphenol

is one of the largest manufacturers of interconnect products in the world. The company designs, manufactures and markets electrical, electronic and fiber optic connectors, coaxial and flat-ribbon cable, and interconnect systems. Amphenol has long been the accepted leader in providing quality connectors and interconnect systems to the Industrial, Military and Telecommunication markets.



Zhuhai Factory 1

With industry leading engineering, design and manufacturing expertise, Amphenol Technology (Zhuhai) Co., Ltd. has earned more than 60 utility patents on its innovative interconnects. Many of the products produced have been certified by independent standards including UL, IEC/TUV, ATEX, IECEx and MA. The facility is also certified to ISO 9001, ISO 14001 and IATF 16949.

Amphenol Technology (Zhuhai) Co., Ltd.

Established in 2007, Amphenol Technology (Zhuhai) Co., Ltd. is a manufacturing facility for Amphenol Industrial Operations, which serves a number of industrial markets, included but not limited to Factory Automation, Transportation, Heavy Equipment, Alternative Energy, Energy Storage, Server/Data Comm and Power Distribution.

Amphenol Technology (Zhuhai) Co., Ltd. covers an area of 28,470m² and is equipped with CNC, plating, injection molding and assembly workshops. This plant specializes in the design and manufacturing of industrial connectors featuring high power, high density, medium to high voltage electrical properties, and harsh environment applications.



Zhuhai Factory 2

Max-M12 Series

Table of Contents

- **Product Introduction/Markets Applications**.....P1
- **X Coding High Speed Max-M12**
 - Female Plug/Female Sockets (HDM12PF08X)
 - Male Plug/Male Pins (HDM12PM08X)P2~P5
 - Female Panel Jam Nut/Female Sockets (HDM12RF08X)
 - Male Panel Jam Nut/Male Pins (HDM12RM08X)P6~P7
- **Standard Solder Max-M12**
 - Female Plug/Female Sockets (HDM12PF)
 - Male Plug/Male Pins (HDM12PM)P8~P11
 - Female Panel Jam Nut/Female Sockets (HDM12RF)
 - Male Panel Jam Nut/Male Pins (HDM12RM).....P12~P15
- **Flange Max-M12**
 - Female Square Flange/Female Sockets (HDM12FF)
 - Male Square Flange/Male Pins (HDM12FM)P16~P17
- **S Coding Max-M12 (First Mate Last Break)**
 - Female Plug/Female Sockets (HDM12PF_S)
 - Male Plug/Male Pins (HDM12PM_S)P18~P19
- **How to Order**P20



Product Introduction

Amphenol Industrial Operations offers standard Max-M12 series (A/B/D/S/X Code) which are based on IEC 61076-2-101 & SAE J2839. In order to save assembly time, we also provide several different mounting options (front or back lock/flange) and wire termination styles (solder/crimp/screw).

To ensure high performance in harsh environments, Amphenol has plating solutions which can meet salt spray protection from 48 to 240 hours. Featuring resistance to High Vibration/Mechanical Shock with an IP67 rating makes Max-M12 a perfect solution for signal & data transmission.

Features & Benefits

- X coding High Speed connector with support for 10Gb/s data transmission
- Quick and secure wire termination
- Wide range of pin positions from 3 pin to 12 pin
- Alternative mounting styles
- Ingress protection rating of IP67
- Vibration/Shock resistance
- S coding, First Mate Last Break



Markets & Applications

- Rail Mass Transit
- Industrial Automation
- Robotics



Max-M12 series

X Coding High Speed Max-M12

Male Straight Plug/Male Pins (HDM12PM08X) - Solder

Product Image (PG9 with shield)



Scale Diagram

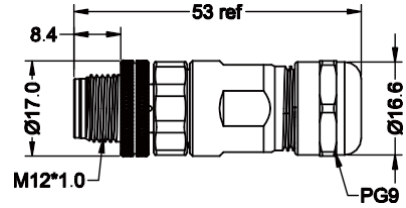

Contact Layouts/针孔排布(Front View/前视图)

8 pins

X



Specifications/技术参数

Number of Contacts/芯数	8
Termination/接线方式	Solder
Wire Gauge/线规	0.14/0.25/0.34/0.5mm ² /(26/24/22/20AWG)
Cable OD/线材直径	6~8mm
Operating Temperature/工作温度	-40°C~+85°C
Mechanical Operation/插拔次数	> 500 mating cycles
Rated Voltage/额定电压	60V
Rated Current (40°C)/额定电流	0.5A
Ingress Progress/防护等级	IP67/IP68
Contact Resistance/接触阻抗	≤5mΩ
Insulation Resistance/绝缘阻抗	≥100mΩ
Pin Contact/插针材料	CuZn
Socket Contact/插孔材料	CuSn
Contact Plating/针孔镀层材料	Au

X Coding High Speed Max-M12

Female Straight Plug / Female Sockets (HDM12PF08X) - Solder

Product Image (PG9 with shield)



Scale Diagram

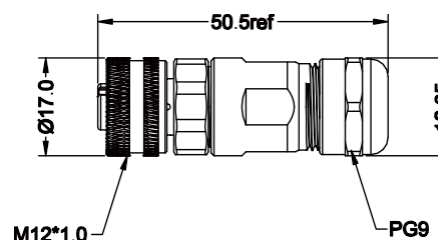

Contact Layouts/针孔排布(Front View/前视图)

8 pins

X



Specifications/技术参数

Number of Contacts/芯数	8
Termination/接线方式	Solder
Wire Gauge/线规	0.14/0.25/0.34/0.5mm ² /(26/24/22/20AWG)
Cable OD/线材直径	6~8mm
Operating Temperature/工作温度	-40°C~+85°C
Mechanical Operation/插拔次数	> 500 mating cycles
Rated Voltage/额定电压	60V
Rated Current(40°C)/额定电流	0.5A
Ingress Progress/防护等级	IP67/IP68
Contact Resistance/接触阻抗	≤5mΩ
Insulation Resistance/绝缘阻抗	≥100mΩ
Pin Contact/插针材料	CuZn
Socket Contact/插孔材料	CuSn
Contact Plating/针孔镀层材料	Au

Max-M12 series

X Coding High Speed Max-M12

Straight Male Plug / Male Pins (HDM12PM08X) - Crimp

Product Image



Scale Diagram

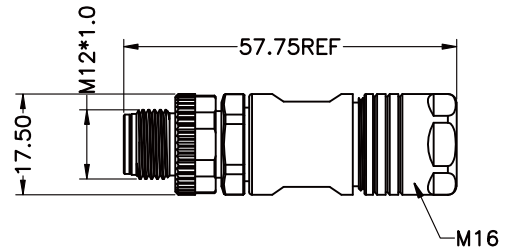

Contact Layouts/针孔排布(Front View/前视图)

8 pins

X



Specifications/技术参数

Number of Contacts/芯数	8
Termination/接线方式	Crimp
Wire Gauge/线规	0.14/0.25/0.34/0.5mm ² (26/24/22/20 AWG)
Cable OD/线材直径	6~8mm
Operating Temperature/工作温度	-40°C ~ +85°C
Mechanical Operation/插拔次数	> 500 mating cycles
Rated Voltage/额定电压	60V
Rated Current (40°C)/额定电流	0.5A
Protection Degree/防护等级	IP67/IP68
Contact Resistance/接触阻抗	≤5mΩ
Insulation Resistance/绝缘阻抗	≥100MΩ
Pin Contact/插针材料	CuZn
Socket Contact/插孔材料	CuSn
Contact Plating/针孔镀层材料	Au

X Coding High Speed Max-M12

Straight Female Plug / Female Sockets (HDM12PF08X) - Crimp

Product Image



Scale Diagram

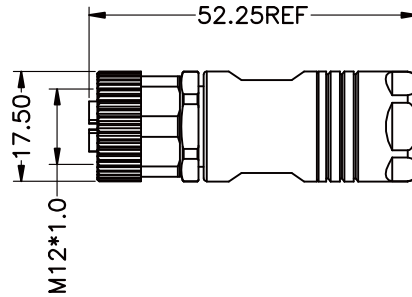

Contact Layouts/针孔排布(Front View/前视图)

8 pins

X



Specifications/技术参数

Number of Contacts/芯数	8
Termination/接线方式	Crimp
Wire Gauge/线规	0.14/0.25/0.34/0.5mm ² (26/24/22/20 AWG)
Cable OD/线材直径	6~8mm
Operating Temperature/工作温度	-40°C~+85°C
Mechanical Operation/插拔次数	> 500 mating cycles
Rated Voltage/额定电压	60V
Rated Current(40°C)/额定电流	0.5A
Protection Degree/防护等级	IP67/IP68
Contact Resistance/接触阻抗	≤5mΩ
Insulation Resistance/绝缘阻抗	≥100MΩ
Pin Contact/插针材料	CuZn
Socket Contact/插孔材料	CuSn
Contact Plating/针孔镀层材料	Au

X Coding High Speed Max-M12

Male Panel Jam Nut / Male Pins (HDM12RM08X) - Straight PC Tail

Product Image (M16*1.5 front mount DIP)



Scale Diagram

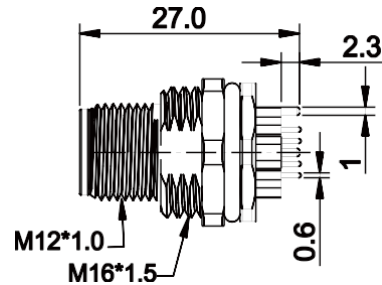

Contact Layouts/针孔排布(Front View/前视图)

8 pins

X



Specifications/技术参数

Number of Contacts/芯数	8
Termination/接线方式	PCB
Wire Gauge/线规	—
Operating Temperature/工作温度	-40°C~+85°C
Mechanical Operation/插拔次数	> 500 mating cycles
Rated Voltage/额定电压	60V
Rated Current (40°C)/额定电流	0.5A
Ingress Progress/防护等级	IP67/IP68
Contact Resistance/接触阻抗	≤5mΩ
Insulation Resistance/绝缘阻抗	≥100mΩ
Pin Contact/插针材料	CuZn
Socket Contact/插孔材料	CuSn
Contact Plating/针孔镀层材料	Au

X Coding High Speed Max-M12

Female Panel Jam Nut / Female Sockets (HDM12RF08X) - Straight PC Tail

Product Image(M16*1.5 front mount DIP)



Scale Diagram

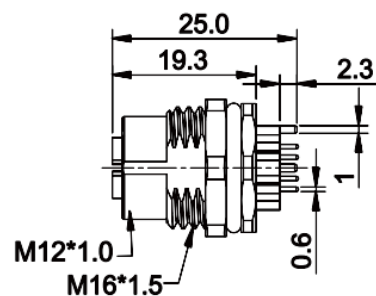

Contact Layouts/针孔排布(Front View/前视图)

8 pins

X



Specifications/技术参数

Number of Contacts/芯数	8
Termination/接线方式	PCB
Wire Gauge/线规	—
Operating Temperature/工作温度	-40 °C~+85 °C
Mechanical Operation/插拔次数	> 500 mating cycles
Rated Voltage/额定电压	60V
Rated Current(40°C)/额定电流	0.5A
Ingress Progress/防护等级	IP67/IP68
Contact Resistance/接触阻抗	≤5mΩ
Insulation Resistance/绝缘阻抗	≥100mΩ
Pin Contact/插针材料	CuZn
Socket Contact/插孔材料	CuSn
Contact Plating/针孔镀层材料	Au

Max-M12 series

Standard Solder Max-M12

Male Straight Plug / Male Pins (HDM12PM_ST)

Product Image (PG7with shield)



Scale Diagram

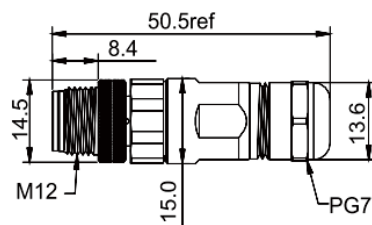

Contact Layouts/针孔排布(Front View/前视图)

3 pins

4 pins

5 pins

8 pins

12 pins

17 pins

5 pins

4 pins

A

A

A

A

A

A

B

D



Specifications/技术参数

Number of Contacts/芯数	3	4	5	8	12	17
Termination/接线方式	Solder					
Wire Gauge/线规	0.14/0.25/0.34/0.5mm ² /(26/24/22/20AWG)					
Cable OD/线材直径	4~6mm					
Operating Temperature/工作温度	-25 °C ~ +85 °C					
Mechanical Operation/插拔次数	> 500 mating cycles					
Rated Voltage/额定电压	250V		60V		30V	
Rated Current(40°C)/额定电流	4A			2A		1.5A
Ingress Progress/防护等级	IP67/IP68					
Contact Resistance/接触阻抗	< 10mΩ					
Insulation Resistance/绝缘阻抗	≥100mΩ					
Pin Contact/插针材料	CuZn					
Socket Contact/插孔材料	CuSn					
Contact Plating/针孔镀层材料	Au					

Standard Solder Max-M12

Female Straight Plug / Female Sockets (HDM12PF_ST)

Product Image (PG7 with shield)



Scale Diagram

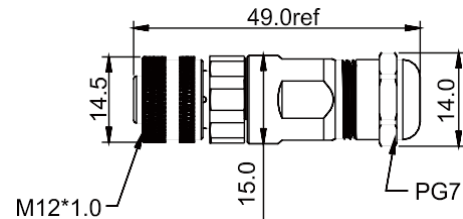

Contact Layouts/针孔排布(Front View/前视图)

3 pins

A



4 pins

A



5 pins

A



8 pins

A



12 pins

A

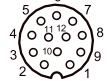

17 pins

A



5 pins

B



4 pins

D

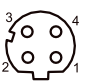

Specifications/技术参数

Number of Contacts/芯数	3	4	5	8	12	17
Termination/接线方式	Solder					
Wire Gauge/线规	0.14/0.25/0.34/0.5mm ² /(26/24/22/20AWG)					
Cable OD/线材直径	4~6mm					
Operating Temperature/工作温度	-25°C~+85°C					
Mechanical Operation/插拔次数	> 500 mating cycles					
Rated Voltage/额定电压	250V		60V		30V	
Rated Current (40°C)/额定电流	4A			2A		1.5A
Ingress Progress/防护等级	IP67/IP68					
Contact Resistance/接触阻抗	< 10mΩ					
Insulation Resistance/绝缘阻抗	≥ 100mΩ					
Pin Contact/插针材料	CuZn					
Socket Contact/插孔材料	CuSn					
Contact Plating/针孔镀层材料	Au					

Max-M12 Series

Standard Solder Max-M12

Male Right Angle Plug / Male Pins (HDM12PM_RA)

Product Image



Scale Diagram

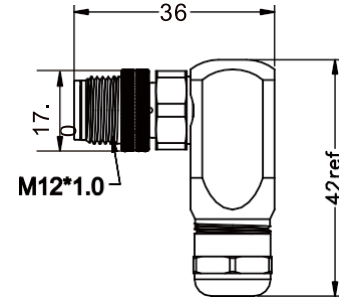

Contact Layouts/针孔排布(Front View/前视图)

4 pins

A



5 pins

A



12 pins

A

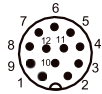

17 pins

A

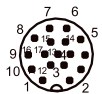

5 pins

B



4 pins

D



Specifications/技术参数

Number of Contacts/芯数	4	5	12	17
Termination/接线方式	Solder			
Wire Gauge/线规	0.14/0.25/0.34/0.5mm ² /(26/24/22/20AWG)			
Cable OD/线材直径	4~6mm			
Operating Temperature/工作温度	-25°C~+85°C			
Mechanical Operation/插拔次数	> 500 mating cycles			
Rated Voltage/额定电压	250V	60V	30V	
Rated Current(40°C)/额定电流	4A		1.5A	
Ingress Progress/防护等级	IP67/IP68			
Contact Resistance/接触阻抗	< 10mΩ			
Insulation Resistance/绝缘阻抗	≥100mΩ			
Pin Contact/插针材料	CuZn			
Socket Contact/插孔材料	CuSn			
Contact Plating/针孔镀层材料	Au			

Standard Solder Max-M12

Female Right Angle Plug / Female Sockets (HDM12PF_RA)

Product Image



Scale Diagram

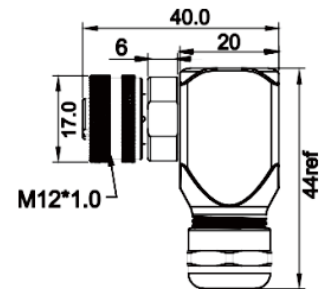

Contact Layouts/针孔排布(Front View/前视图)

4 pins

A



5 pins

A



12 pins

A

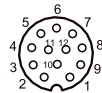

17 pins

A



5 pins

B



4 pins

D



Specifications/技术参数

Number of Contacts/芯数	4	5	12	17
Termination/接线方式	Solder			
Wire Gauge/线规	0.14/0.25/0.34/0.5mm ² /(26/24/22/20AWG)			
Cable OD/线材直径	4~6mm			
Operating Temperature/工作温度	-25 °C ~ +85 °C			
Mechanical Operation/插拔次数	> 500 mating cycles			
Rated Voltage/额定电压	250V	60V	30V	
Rated Current(40°C)/额定电流	4A		1.5A	
Ingress Progress/防护等级	IP67/IP68			
Contact Resistance/接触电阻	< 10mΩ			
Insulation Resistance/绝缘电阻	≥ 100mΩ			
Pin Contact/插针材料	CuZn			
Socket Contact/插孔材料	CuSn			
Contact Plating/针孔镀层材料	Au			

Max-M12 series

Standard Solder Max-M12

Male Panel Jam Nut / Male Pins PCB Straight (HDM12RM_PS)

Product Image (PG9 rear mount DIP)



Scale Diagram

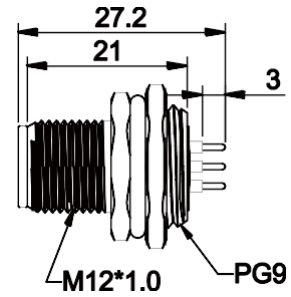

Contact Layouts/针孔排布(Front View/前视图)

3 pins

A



4 pins

A



5 pins

A



8 pins

A



12 pins

A

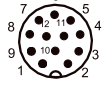

17 pins

A



5 pins

B



4 pins

D



Specifications/技术参数

Number of Contacts/芯数	3	4	5	8	12	17
Termination/接线方式	PCB					
Wire Gauge/线规	—					
Operating Temperature/工作温度	-25°C~+85°C					
Mechanical Operation/插拔次数	> 500 mating cycles					
Rated Voltage/额定电压	250V		60V		30V	
Rated Current (40°C)/额定电流	4A			2A	1.5A	
Ingress Progress/防护等级	IP67/IP68					
Contact Resistance/接触阻抗	< 10mΩ					
Insulation Resistance/绝缘阻抗	≥100mΩ					
Pin Contact/插针材料	CuZn					
Socket Contact/插孔材料	CuSn					
Contact Plating/针孔镀层材料	Au					

Standard Solder Max-M12

Female Panel Jam Nut / Female Sockets PCB Straight (HDM12RF_PS)

Product Image (M16*1.5 rear mount DIP)



Scale Diagram

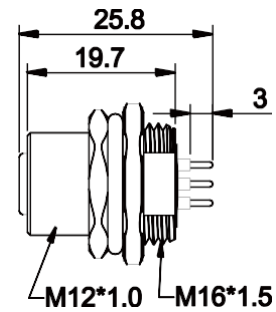

Contact Layouts/针孔排布(Front View/前视图)

3 pins

A



4 pins

A



5 pins

A



8 pins

A



12 pins

A

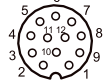

17 pins

A



5 pins

B



4 pins

D

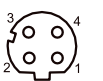

Specifications/技术参数

Number of Contacts/芯数	3	4	5	8	12	17
Termination/接线方式	PCB					
Wire Gauge/线规	—					
Operating Temperature/工作温度	-25°C ~ +85°C					
Mechanical Operation/插拔次数	> 500 mating cycles					
Rated Voltage/额定电压	250V		60V		30V	
Rated Current (40°C)/额定电流	4A			2A		1.5A
Ingress Progress/防护等级	IP67/IP68					
Contact Resistance/接触阻抗	< 10mΩ					
Insulation Resistance/绝缘阻抗	≥ 100mΩ					
Pin Contact/插针材料	CuZn					
Socket Contact/插孔材料	CuSn					
Contact Plating/针孔镀层材料	Au					

Max-M12 series

Standard Solder Max-M12

Male Panel Jam Nut / Male Pins PCB Right Angle (HDM12RM_PR)

Product Image (M12*1.0 90° front mount DIP)



Scale Diagram

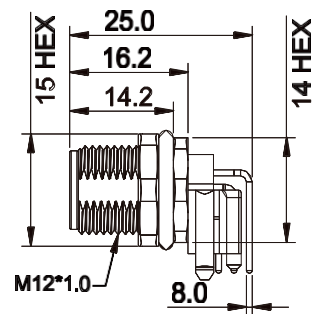

Contact Layouts/针孔排布(Front View/前视图)

3 pins

A



4 pins

A



5 pins

A



8 pins

A

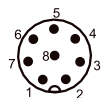

12 pins

A

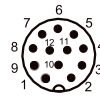

5 pins

B



4 pins

D



Specifications/技术参数

Number of Contacts/芯数	3	4	5	8	12
Termination/接线方式	PCB				
Wire Gauge/线规	—				
Operating Temperature/工作温度	-25°C ~ +85°C				
Mechanical Operation/插拔次数	> 500 mating cycles				
Rated Voltage/额定电压	250V		60V	30V	
Rated Current (40°C)/额定电流	4A			2A	1.5A
Ingress Progress /防护等级	IP67/IP68				
Contact Resistance/接触阻抗	< 10mΩ				
Insulation Resistance/绝缘阻抗	≥ 100mΩ				
Pin Contact/插针材料	CuZn				
Socket Contact/插孔材料	CuSn				
Contact Plating/针孔镀层材料	Au				

Standard Solder Max-M12

Female Panel Jam Nut / Female Sockets PCB Right Angle (HDM12RF_PR)

Product Image(M12*1.0 90° front mount DIP)



Scale Diagram

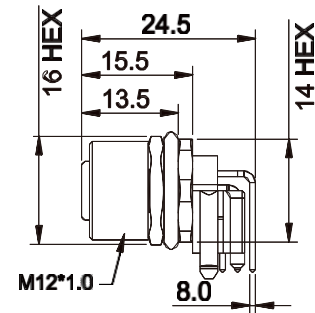

Contact Layouts/针孔排布(Front View/前视图)

3 pins

A



4 pins

A



5 pins

A



8 pins

A

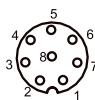

12 pins

A

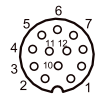

5 pins

B



4 pins

D



Specifications/技术参数

Number of contacts/芯数	3	4	5	8	12
Termination/接线方式	PCB				
Wire Gauge/线规	—				
Operating Temperature/工作温度	-25°C~+85°C				
Mechanical Operation/插拔次数	> 500 mating cycles				
Rated Voltage/额定电压	250V		60V	30V	
Rated Current (40°C)/额定电流	4A			2A	1.5A
Ingress Progress/防护等级	IP67/IP68				
Contact Resistance/接触阻抗	< 10mΩ				
Insulation Resistance/绝缘阻抗	≥ 100mΩ				
Pin Contact/插针材料	CuZn				
Socket Contact/插孔材料	CuSn				
Contact Plating/针孔镀层材料	Au				

Flange Max-M12

Male Square Flange / Male Pins (HDM12FM)

Product Image (flanged fixed)



Scale Diagram

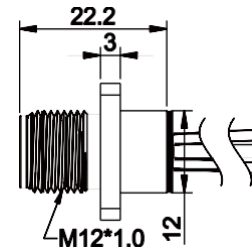

Contact Layouts/针孔排布(Front View/前视图)

3 pins

A



4 pins

A



5 pins

A



8 pins

A



12 pins

A



17 pins

A



5 pins

B



4 pins

D



Specifications/技术参数

Number of Contacts/芯数	3	4	5	8	12	17
Termination/接线方式	Solder					
Wire Gauge/线规	0.14/0.25/0.34/0.5mm ² /(26/24/22/20AWG)					
Operating Temperature/工作温度	-25°C~+85°C					
Mechanical Operation/插拔次数	> 500 mating cycles					
Rated Voltage/额定电压	250V		60V		30V	
Rated Current (40°C)/额定电流	4A			2A	1.5A	
Ingress Progress/防护等级	IP67/IP68					
Contact Resistance/接触阻抗	< 10mΩ					
Insulation Resistance/绝缘阻抗	≥100mΩ					
Pin Contact/插针材料	CuZn					
Socket Contact/插孔材料	CuSn					
Contact Plating/针孔镀层材料	Au					

Flange Max-M12

Female Square Flange / Female Sockets (HDM12FF)

Product Image (flanged fixed)

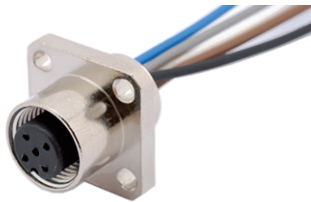

Scale Diagram

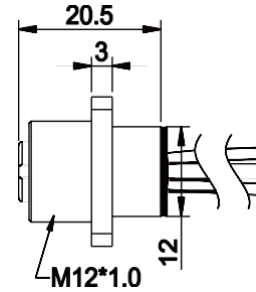

Contact Layouts/针孔排布(Front View/前视图)

3 pins

4 pins

5 pins

8 pins

12 pins

17 pins

5 pins

4 pins

A

A

A

A

A

A

B

D

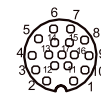
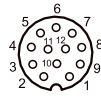
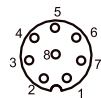

Specifications/技术参数

Number of Contacts/芯数	3	4	5	8	12	17
Termination/接线方式	Solder					
Wire Gauge/线规	0.14/0.25/0.34/0.55mm ² /(26/24/22/20AWG)					
Operating Temperature/工作温度	-25°C ~ +85°C					
Mechanical Operation/插拔次数	> 500 mating cycles					
Rated Voltage/额定电压	250V		60V		30V	
Rated Current (40°C)/额定电流	4A			2A		1.5A
Ingress Progress/防护等级	IP67/IP68					
Contact Resistance/接触阻抗	< 10mΩ					
Insulation Resistance/绝缘阻抗	≥ 100mΩ					
Pin Contact/插针材料	CuZn					
Socket Contact/插孔材料	CuSn					
Contact Plating/针孔镀层材料	Au					

S Coding Max-M12 (First Mate Last Break)

Male Straight Plug / Male Pins (HDM12PM_S)

Product Image



Scale Diagram

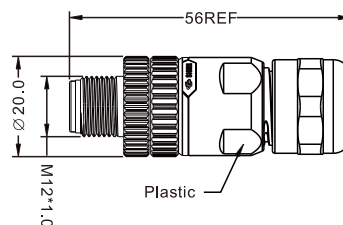

Contact Layouts/针孔排布(Front View/前视图)

2+PE

S



3+PE

S



Specifications/技术参数

Number of Contacts/芯数	2+PE	3+PE
Termination/接线方式		
Wire Gauge/线规	max. 1.5mm ² (max.16 AWG)	
Cable OD/线材直径	3~8mm	
Operating Temperature/工作温度	-40°C~+85°C	
Mechanical Operation/插拔次数	> 500 mating cycles	
Rated Voltage/额定电压	630V	
Rated Current (40°C)/额定电流	16A	12A
Protection Degree/防护等级	IP67/IP68	
Contact Resistance/接触阻抗	≤3mΩ	
Insulation Resistance/绝缘阻抗	≥100MΩ	
Pin Contact/插针材料	CuZn	
Socket Contact/插孔材料	CuSn	
Contact Plating/针孔镀层材料	Au	

S Coding Max-M12(First Mate Last Break)

Female Straight Plug / Female Sockets (HDM12PF_S)

Product Image



Scale Diagram

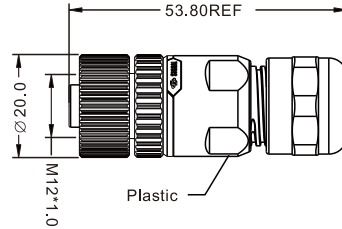

Contact Layouts/针孔排布(Front View/前视图)

2+PE

S



3+PE

S



Specifications/技术参数

Number of Cntacts/芯数	2+PE	3+PE
Termination/接线方式	Solder	
Wire Gauge/线规	max. 1.5mm ² (max.16 AWG)	
Cable OD/线材直径	3~8mm	
Operating Temperature/工作温度	-40°C~+85°C	
Mechanical Operation/插拔次数	> 500 mating cycles	
Rated Voltage/额定电压	630V	
Rated Current (40°C)/额定电流	16A	12A
Protection Degree/防护等级	IP67/IP68	
Contact Resistance/接触阻抗	≤3mΩ	
Insulation Resistance/绝缘阻抗	≥100MΩ	
Pin Contact/插针材料	CuZn	
Socket Contact/插孔材料	CuSn	
Contact Plating/针孔镀层材料	Au	

How to Order

1	2		3		4		5				
Product Series	Insert Material		Shell Style / Contact Gender		Insert Arrangement		Coding				
HDM12		Omit for standard	PF	Female Plug / Female Sockets	03	3 Pole	A	B	D	S	X
	H	High Impact (Consult AIO for Arrangement and Coding availability)	PM	Male Plug / Male Pins	04	4 Pole	*	*	*	2+PE	
			RF	Female Panel Jam Nut / Female Sockets	05	5 Pole	*	*	*	3+PE	
			RM	Male Panel Jam Nut / Male Pins	08	8 Pole	*	*	*		*
			FF	Female Flange / Female Sockets	12	12 Pole	*				
			FM	Male Flange / Male Pins	17	17 Pole**	*				

**not available in Panel connectors with Right Angle PC Tail

6		7		8			9	
Backshell		Backshell Material		Contact Type			Protection Cap	
ST	Straight	M	Metal	PR	Right Angle PC Tail (Male and Female Panel Jam Nut only)		P	Plastic cap
RA	Right Angle	P	Plastic	PS	Straight PC Tail (Male and Female Panel Jam Nut only)		M	Metal cap
Omit for no backshell				C	Crimp Contact (Male and Female plugs only)			Omit for no cap
					Omit for solder contact (Cable/Flange Plugs & Receptacles only)			

Part Number Example:

1. M12 Plug Male 8 Pin A Coding Gold Plating Straight Metal Backshell Crimp contact : **HDM12PM08ASTMC**
2. M12 Receptacle Male Pin 17 Pin A Coding Gold Plating Straight No Backshell Right Angle Through Hole PCB : **HDM12RM17APR**

North America

Amphenol Industrial Operations

20 Valley Street
Endwell, NY 13760-3600
USA

Tel: +1-888-364-9011 Fax: +1-520-397-7169

www.amphenol-industrial.com

Email: tech@amphenol-aio.com

Asia

Amphenol Technology(Zhuhai) Co., Ltd.

No.63, Xinghan Road, Sanzao Town,
Jinwan, Zhuhai, 519040
China

Tel: +86-756-398 9725 Fax: +86-756-398 9768

www.amphenol-industrial.com

Email: tech@amphenol-aio.com



IC-15-1

Notice: Specifications are subject to change without notice. Contact your nearest Amphenol Corporation Sales Office for the latest Specifications. All statements, information and data given herein are believed to be accurate and reliable but are presented without guarantee, warranty, or responsibility of any kind expressed or implied. Statements or suggestions concerning possible use of our products are made without representation or warranty that any such use is free of patent infringement and are not recommendations to infringe any patent. The user should not assume that all safety measures are indicated or that other measures may not be required. Specifications are typical and may not apply to all connectors.